

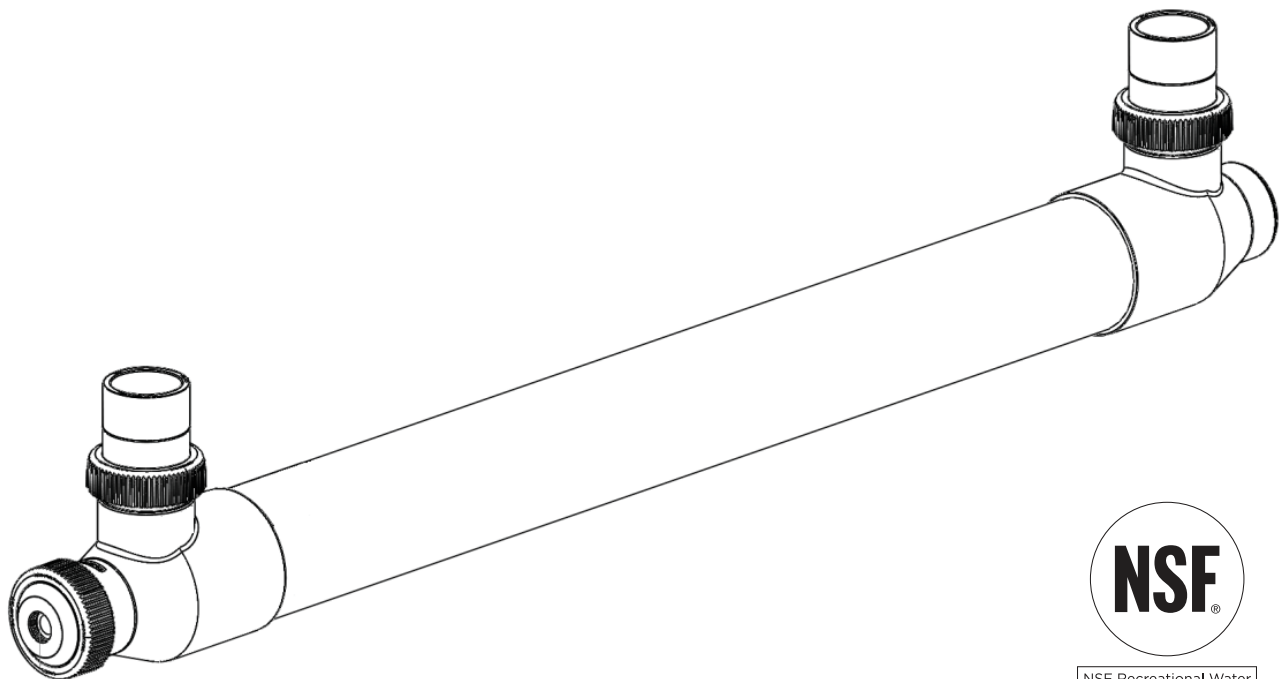

BIOSHIELD[®]

UV SYSTEM



NSF Recreational Water
CCS-18325



INSTALLATION AND USER'S GUIDE

IMPORTANT SAFETY INSTRUCTIONS
READ AND FOLLOW ALL INSTRUCTIONS
SAVE THESE INSTRUCTIONS

CUSTOMER SERVICE / TECHNICAL SUPPORT

If you have questions about ordering Pentair Aquatics Systems replacement parts and products, please contact:

Customer Service and Technical Support, USA
(8 A.M. to 4:30 P.M. — Eastern/Pacific Times)
Phone: (800) 831-7133
Fax: (800) 284-4151

Web site
Visit www.pentair.com for information about Pentair products.

Sanford, North Carolina (8 A.M. to 4:30 P.M. ET)
Phone: (919) 566-8000
Fax: (919) 566-8920

Moorpark, California (8 A.M. to 4:30 P.M. PT)
Phone: (805) 553-5000 (Ext. 5591)
Fax: (805) 553-5515

©2019 Pentair Water Pool and Spa, Inc. All rights reserved.

This document is subject to change without notice.

1620 HAWKINS AVE., SANFORD, NC 27330 • (919) 566-8000

10951 WEST LOS ANGELES AVE., MOORPARK, CA 93021 • (805) 553-5000

WWW.PENTAIR.COM

All Pentair trademarks and logos are owned by Pentair or one of its global affiliates. Pentair Aquatic Systems®, IntelliTouch®, EasyTouch® and Bioshield® are registered trademarks of Pentair Water Pool and Spa, Inc. and/or its affiliated companies in the United States and/ or other countries. Unless expressly noted, names and brands of third parties that may be used in this document are not used to indicate an affiliation or endorsement between the owners of these names and brands and Pentair Water Pool and Spa, Inc. Those names and brands may be the trademarks or registered trademarks of those third parties. Because we are continuously improving our products and services, Pentair reserves the right to change specifications without prior notice. Pentair is an equal opportunity employer.

P/N 960080 Rev. I 8/19

TABLE OF CONTENTS

Important Safety Instructions	4	Operation	16
System Features and Specifications	6	Initial Start-Up	16
Bioshield Features.....	6	Maintenance	17
System Specifications.....	6	UV Lamp Replacement	17
Sizing Chart	6	Quartz Sleeve Cleaning.....	17
Pre-Installation Inspection	7	Winterizing	18
Serial Number	7	Troubleshooting	19
Component Diagram	7	Replacements Parts	20
Power Supplies	7	Revision 3 UV unit with Flow Switch	20
Flow Switch.....	7	Revision 3 UV unit.....	21
Quartz Sleeve and UV Lamp Inspection	8	Revision 2 UV unit.....	22
Installation	9		
Quartz Sleeve Assembly and Installation	9		
Typical Installation.....	10		
Mounting the Vessel.....	11		
Mounting the Power Supply.....	11		
Flow Switch Plumbing.....	11		
Mandatory Leak Test.....	12		
Electrical Connection	13		
Flow Switch Electrical	13		
UV Lamp Installation	14		

IMPORTANT SAFETY INSTRUCTIONS



IMPORTANT NOTICE

This guide provides installation and operation instructions for the UV. Consult Pentair with any questions regarding this equipment.

Attention Installer: This guide contains important information about the installation, operation and safe use of this product. This information should be given to the owner and/or operator of this equipment after installation or left on or near the UV system.

Attention User: This manual contains important information that will help you in operating and maintaining this product. Please retain it for future reference.

IMPORTANT SAFETY INSTRUCTIONS! PLEASE READ PRIOR TO INSTALLATION AND OPERATION!

Strictly follow the instructions within this manual to ensure the health and safety of both, yourself and the UV system. The installation, operation and maintenance of the UV system can only be carried out after reading and understanding the information contained in this manual.

The installation of the UV system must be carried out in accordance with local regulations and codes.

READ AND FOLLOW ALL INSTRUCTIONS

 This is the safety alert symbol. When you see this symbol on your system or in this manual, look for one of the following signal words and be alert to the potential for personal injury.

 **DANGER** Warns about hazards that can cause death, serious personal injury, or major property damage if ignored.

 **WARNING** Warns about hazards that may cause death, serious personal injury, or major property damage if ignored.

 **CAUTION** Warns about hazards that may or can cause minor personal injury or property damage if ignored.

NOTE Indicates special instructions not related to hazards.

Carefully read and follow all safety instructions in this manual and on equipment. Keep safety labels in good condition; replace if missing or damaged.

When installing and using this electrical equipment, basic safety precautions should always be followed, including the following:

 **DANGER** FAILURE TO FOLLOW ALL INSTRUCTIONS AND WARNINGS CAN RESULT IN SERIOUS BODILY INJURY OR DEATH.

THIS UV SYSTEM SHOULD BE INSTALLED AND SERVICED ONLY BY A QUALIFIED POOL SERVICE PROFESSIONAL. INSTALLERS, POOL OPERATORS AND OWNERS MUST READ THESE WARNINGS AND ALL INSTRUCTIONS IN THE OWNER'S MANUAL BEFORE USING THIS PRODUCT. THESE WARNINGS AND THE OWNER'S MANUAL MUST BE LEFT WITH THE POOL OWNER.

 **WARNING** Ultraviolet light is damaging to your eyes and skin! DO NOT handle or stare at an operating UV lamp.

NOTE that the UV light rays are invisible to the human eye and precautions should be taken to prevent UV energy from entering the eyes.

 **DANGER** ULTRAVIOLET RADIATION. Failure to disconnect the power from the UV Sterilizer and pump before servicing the unit or replacing the lamp could result in personal injury or property damage. Confirm the lamp is completely off, via the view port, before attempting lamp replacement.

 **CAUTION** The quartz sleeve and or the UV lamp shipped with this product may have been broken or damaged during transit. It is therefore essential that the unit be carefully inspected before connecting to electrical power.

 **CAUTION** To prevent possible fire or electrical shock, only use replacement lamps specified by the manufacturer.

 **WARNING** DO NOT allow system to exceed 50 PSI (Pounds Per Square Inch).

 **CAUTION** DO NOT operate this unit above 100 GPM. Operating the product in this manner may result in product failure and voiding of warranty.

 **DANGER** To avoid possible electrical shock, special care should be taken since water is employed in intended applications. For each of the following situation, DO NOT attempt repairs yourself. Call Pentair Water Pool and Spa, Inc. customer service department at (800) 831-7133 for services or discard the appliance.

IMPORTANT SAFETY INSTRUCTIONS

⚠ DANGER If unit falls into the water, DO NOT REACH FOR IT! First power down the unit and then retrieve it. If the internal electrical components of the unit get wet, keep the unit powered down until internal electrical components have dried.

⚠ DANGER If the unit shows any sign of water leakage, immediately power down the unit.

⚠ CAUTION Carefully examine the unit after installation. It should not be powered on if there is water on any part not intended to be wet.

⚠ WARNING To reduce the risk of injury, DO NOT permit children to use this product.

⚠ WARNING Bioshield UV systems are designed for low-pressure water applications DO NOT use these units for any application outside of their intended use. The use of attachments not recommended or sold by the original manufacturer may cause unsafe conditions and may void any warranty.

⚠ WARNING This unit must be wired in conjunction with a properly grounded, Ground Fault Circuit Interrupter (GFCI). Only three (3) wire grounded cables suitable for outdoor use should be used to connect this unit. If joining cables for outdoor use, a suitable watertight cable connector must be used. If an extension cord is necessary, a cord with a proper rating should be used. A cord rated for less amperes or watts than the appliance's rating may overheat. Care should be taken to arrange the cord so that it will not be tripped over or pulled. If in doubt consult a qualified electrician.

⚠ WARNING Warping of the UV body may occur when left in direct sunlight without water inside to help dissipate the heat.

⚠ WARNING DO NOT operate the unit in "no-flow" situations.

SAVE THESE INSTRUCTIONS

SYSTEM FEATURES AND SPECIFICATIONS

Bioshield Features

Our low-pressure, high-output mercury vapor germicidal lamps, convert approximately 40% of their electrical input watts into UV-C output watts within the germicidal action spectrum (meaning 40% of electricity used is converted into useful germicidal UV light), the highest UV-C output conversion among all UV lamps.

- UL listed for indoor and outdoor use
- Long lasting, low-pressure, high-output lamps (12,000 hours to 80% efficiency).
- Protective Quartz Sleeve (maximizes UV lamp output and safety)
- Remote Power Supply (20-ft. cable to power supply and 6-ft. cord)
- Flow Switch input to Power Supply (20-ft. cable to power supply)
- UV Resistant High Density Plastic UV Vessel
- Non-UV Transmitting Clear Lamp Viewing Ports

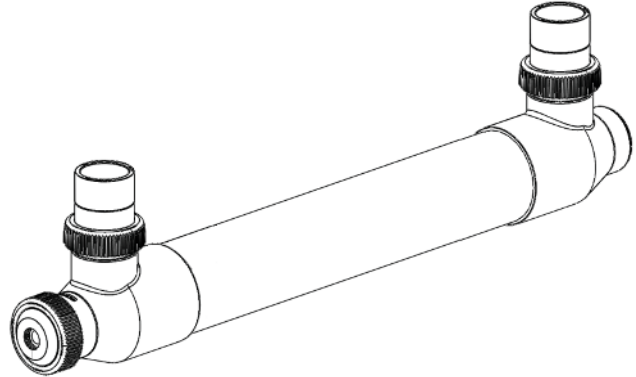

System Specifications

Model No.	Max Flow Rate @ 30 mJ/cm ²	Lamp Wattage	Amperes (A)	UV-C Output Watts	Dimensions H x W (Inches)	Input Voltage	Pressure Loss
522635	25 GPM	50	0.98-0.43	15	28" x 5.75"	120/240 VAC 50/60 Hz	Less than 0.5 PSI
522636	45 GPM	80	0.98-0.43	27	43" x 5.75"	120/240 VAC 50/60 Hz	Less than 0.5 PSI
522637	62 GPM	120	0.98-0.43	36	56" x 5.75"	120/240 VAC 50/60 Hz	Less than 0.5 PSI
522638	100 GPM	150	1.82-0.91	57	70" x 5.75"	120/240 VAC 50/60 Hz	Less than 0.5 PSI

Sizing Chart

Model No.	Max Flow Rate @ 30 mJ/cm ²	Turnover Rate in GPM Determined by Daily Hours of Operation									
		Hours									
		6	8	10	12	14	16	18	20	22	24
522635	25 GPM	9,000	12,000	15,000	18,000	21,000	24,000	27,000	30,000	33,000	36,000
522636	45 GPM	16,200	21,600	27,000	32,400	37,800	43,200	48,600	54,000	59,400	64,800
522637	62 GPM	22,320	29,760	37,200	44,640	52,080	59,520	66,960	74,400	81,840	89,280
522638	100 GPM	36,000	48,000	60,000	72,000	84,000	96,000	108,000	120,000	132,000	144,000
Estimated Lamp Life*		5.5	4.1	3.3	2.7	2.3	2.1	1.8	1.6	1.5	1.4

NOTE (*): Lamp life estimates given above are based on a system that is in continuous operation, 365 days a year. Actual lamp life will vary based on specific operation schedules.

PRE-INSTALLATION INSPECTION

All Bioshield® UVs are packaged complete, with all necessary components that are required to operate the unit. When unpacking your Bioshield UV system, we recommend that a complete component inventory be taken to ensure that all components are included and accounted for, prior to installation.

Bioshield units have their serial number labels located on the UV vessel.

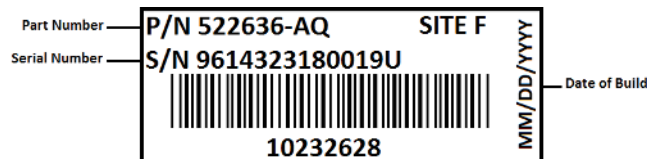

Serial Number



The model number of your UV unit can be found in two locations:

1. On the bar code label at the end of the box.
2. On the label placed in the middle of the UV Vessel.

Component Diagram

Please review the component diagram below. Unpack your UV system, and lay out the packaged components for inspection. Please review the information listed in this section to become familiar with the equipment's various parts.

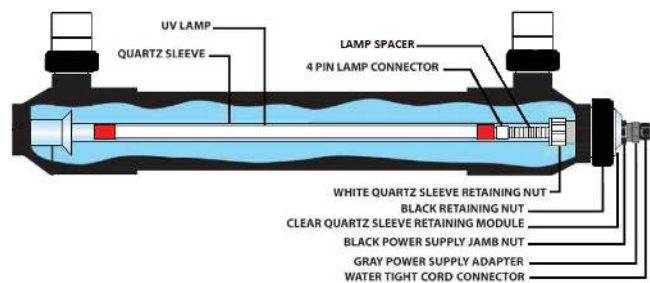

Power Supplies



P/N 960488: 50W, 80W and 120W MODELS (120V/240V)



P/N 960489: 150W MODEL (120/240V)

Flow Switch

The flow switch connects to the ballast via a black M12 male connector, on a 10 feet cable to deactivate the UV lamp during low flow conditions.



PRE-INSTALLATION INSPECTION

Quartz Sleeve and UV Lamp Inspection

Bioshield® UVs are packaged with their quartz sleeve assembly pre-assembled inside the UV vessel. The UV lamp is packaged separately in a corrugated tube.

The Quartz Sleeve Assembly must be removed from the UV vessel and inspected for damage prior to installation. Extreme care should be used while this procedure is being performed.

NOTE: DO NOT handle the lamp or quartz sleeve with bare hands. Your hands can deposit oils on the quartz sleeve and lamp that will decrease the efficiency of the UV.

1. Carefully unpack the UV lamp and quartz sleeve from their corrugated packing tube and inspect for damage including broken glass, cracks, chips, fractures and pin holes. If damage has occurred please contact the place of original purchase immediately.

NOTE: Save the corrugated lamp packaging after unpacking the UV lamp. Storing the lamp and/or quartz sleeve in this packaging while performing maintenance on the UV system will protect these components from damage or fouling when outside of the vessel.

2. After inspection, assemble the quartz sleeve into the UV vessel. If installing the unit, perform the Mandatory Leak Test (see page 12).
3. Inspect all other UV system components (power supply, UV vessel unions and necessary mounting clamps) for damage.

After receipt and inspection of the unit, if broken glass is found (including cracks, chips, pin holes and hair line fractures of any kind) please contact Pentair Water Pool and Spa, Inc. at (800) 831-7133.

INSTALLATION

Quartz Sleeve Assembly and Installation

⚠ WARNING Improper assembly may result in water damage to electrical components and unsafe conditions. The manufacturer is not responsible for damage caused by improper re-assembly of these parts.

Quartz Sleeve Assembly Includes:

1. Quartz Sleeve
2. Quartz Sleeve Module Retaining Nut
3. Quartz Sleeve Module Compression Gasket
4. Quartz Sleeve Module Compression O-Ring
5. Quartz Sleeve Module Sealing Gasket
6. Quartz Sleeve Module

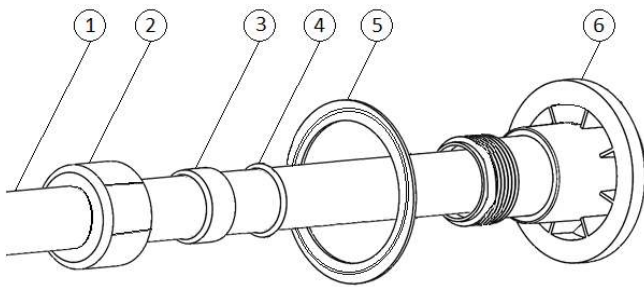

Assembly Instructions

1. Position the white quartz sleeve retaining nut and rubber gasket over the open end of the quartz sleeve.
2. Slide the “open-end” of the quartz sleeve (with nut/gasket in position) into the clear quartz sleeve module
3. Thread the white retaining nut onto the clear quartz sleeve module’s male threads and hand-tighten.
4. While hand-tightening the white retaining nut onto the clear quartz sleeve module, use your index finger to ensure that the open-end of the quartz sleeve mates smoothly with the inside lip of the clear quartz sleeve module; this signifies a good fit.



5. With the quartz sleeve positioned inside the clear quartz sleeve module properly, finish hand-tightening the white retaining nut. When the white retaining nut is tight, the quartz sleeve should appear straight inside the clear quartz sleeve module.

NOTE: If the quartz sleeve appears crooked it may leak. Disassemble and try again.

6. Carefully slide the quartz sleeve assembly into the UV vessel. The domed-end of the quartz sleeve should slide into the coupling located on the non-electrical end of the UV vessel.



7. With the quartz sleeve assembly properly in place, the quartz sleeve retaining module should sit flush against the top of the UV vessel.



8. Thread the black retaining nut onto the male threads of the UV vessel. Hand tighten only!



9. Using the instructions given on page 12, perform the Mandatory Leak Test. If no leaks are found proceed to page 14, *UV Lamp Installation*, for instructions on installing the UV lamp.

INSTALLATION

CAUTION DO NOT operate the UV system at flow rates higher than 100 GPM. Operating the product in this manner may result in product failure and voiding of warranty.

NOTE: The Bioshield UV System has been certified as a water conditioning device only. These units have not been certified for supplemental or secondary disinfection use.

These units have been certified to provide:

- Reduction in Chloramines

Bioshield® UVs are used in a variety of applications to control waterborne pathogens. Pentair encourages the consideration of the installation recommendations provided here.

Suspended solid debris will absorb UV light and reduce the UV transmittance through water. By operating the Bioshield UV system after the mechanical filter, the unit's overall performance will be increased.

When operating UVs consider the recommended water flow rates found in the "Sizing Chart", on page 1.

Typical Installation

(See Diagram Below)

This system achieves critical filtering goals, such as good water circulation. The bottom drain/surface skimming capabilities ensure maximum debris removal.

The UV must be positioned after the mechanical filter where it can receive only solid debris free water, optimizing UV transmittance/performance. If you have a flow rate that exceeds the UV vessels rated flow, install a bypass loop.

The Q-10 fluid flow switch is supplied with a 2 1/2" x 1" PVC T. Teflon™ tape, which must be intact or renewed if needed. If new tape is required apply a minimum of 2 to a maximum of 3 wraps of Teflon tape to threads of bushing.

Tighten unit in tee until fluid leaks are eliminated, flow target is approximately centered along axis of pipe and flow direction arrows located on unit are aligned parallel with flow in pipe. When threading into PVC fittings 2-3 layers of Teflon sealing tape is recommended. Tighten 2-3 turns beyond finger tight.

NOTE: Before gluing pipe or reducer bushing into the UV vessel's union or socket, remove the quartz sleeve assembly to prevent glue from dripping onto the quartz sleeve.

NOTE: Use thread seal tape on all threaded connections.

Typical Installation

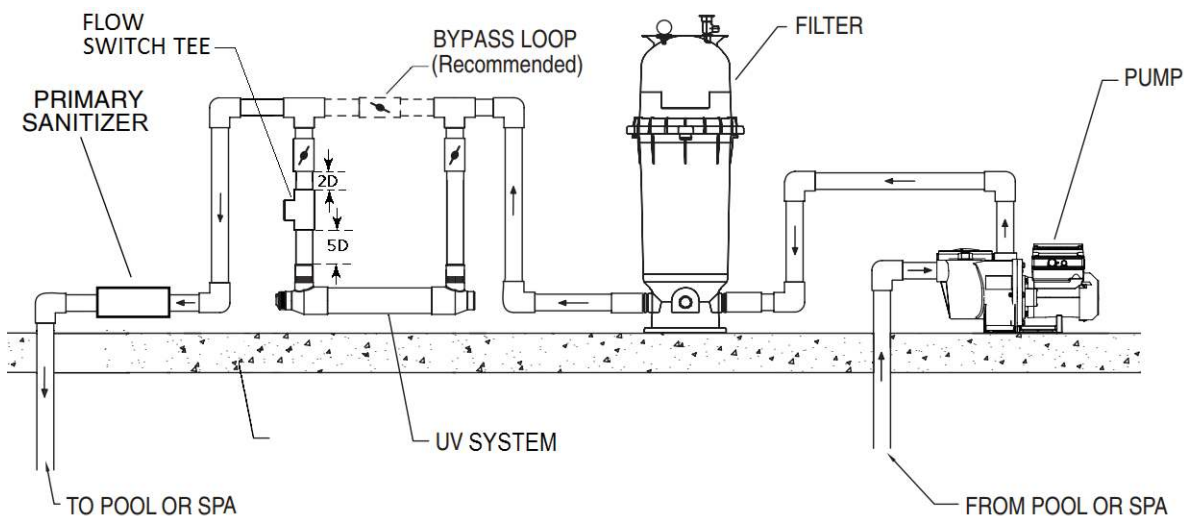

Flow Path: Skimmer(s)/Drain(s) > Pump > Filter > UV > Primary Sanitizer > Pool Returns

INSTALLATION

Mounting the Vessel

NOTE: The way UV vessels are mounted/positioned plays a very important role in the unit's performance and degree of safety. We **STRONGLY RECOMMEND** that you follow these instructions and guidelines precisely. Any deviation from these mounting instructions will void any warranty associated with the UV vessel and all its components and may cause unsafe conditions.

CAUTION Trapped air inside the UV vessel during operation may create excessive heat thus damaging internal components.

Mounting Clamps

The UV system is furnished with mounting clamps and spacers. The mounting clamps are designed to fit around the top quartz sleeve port and the bottom clear plug port. The spacers allow for more clearance for the air relief and drain ports.

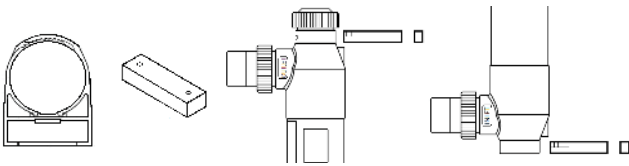

Vertical

Mount the Bioshield® UV with the electrical end up. Use the bottom port as the inlet with the top port as the outlet.

Inlet and outlet plumbing must be supported or damage to the UV vessel may occur.

NOTE: The UV vessel should be installed with a vertical clearance 1-1/2 times the vessel length. This will allow sufficient room for servicing the unit and replacing the UV lamp.

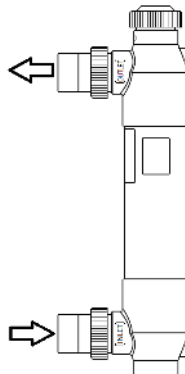

Horizontal

Mount the Bioshield® UV system horizontally with the inlet/outlet facing up.

Inlet and outlet plumbing must be supported or damage to the UV vessel may occur.

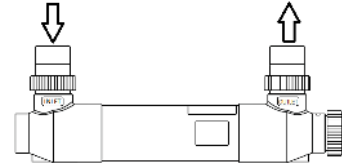

NOTE: The UV vessel should be installed with a horizontal clearance 1-1/2 times the vessel length. This will allow sufficient room for servicing the unit and replacing the UV lamp.

Mounting the Power Supply

The Bioshield UV system's power supply should always be mounted to a surface which does not expose the power supply to standing water.

Position ballast closer to the UV unit than the flow switch. The flow switch has an additional 10 feet of cable.

NOTE: DO NOT mount the power supply in an extremely confined space where heat and moisture can be retained.

Your UV system will include one of two different power supplies based on the wattage of your unit:

- Four screws, one in each corner of the power supply, secure the power supply to the wall or shelf.



Flow Switch

The recommended position for flow switch installation is on the outlet of the UV system. Ensure the flow switch is not subject to flow agitation resulting in false flow conditions.

Care must be exercised during threading operation to insure threads are not crossed and the bending beam target assembly does not touch the inside surface of the tee. When threading into PVC fittings 2-3 layers Teflon sealing tape is recommended.

Tighten 2-3 turns beyond finger tight.

INSTALLATION

Mandatory Leak Test

A leak test should be performed each time the quartz sleeve is installed inside the unit's vessel or when the quartz sleeve or gasket is replaced [Once annually]. Performing a leak test is a precautionary measure that will determine whether or not the critical seal between the quartz sleeve and quartz sleeve module has been achieved.

Failure to achieve a proper quartz sleeve/quartz sleeve module seal during Bioshield® UV operation will allow water to leak into the inside of the quartz sleeve, potentially damaging the UV lamp and other electrical components, which could develop into dangerous situations.

IMPORTANT NOTE: Failure to perform a leak test could lead to conditions that will void your product warranty.

To Perform Mandatory Leak Test:

1. Prepare the UV system for permanent operation by plumbing it in-line, into a filter system using the plumbing hardware of your choice. If PVC glue is used, follow the glue manufacturer's instructions.
2. If UV lamp is installed, with the unit plumbed for operation and the clear quartz sleeve module securely in place, remove the UV lamp from the quartz sleeve module.
3. Roll-up a few paper towels creating a core approximately 3/4-inch diameter, 10-inches long then slide into the open quartz sleeve module port. Insert about 6-inches of the paper towel core down into the quartz sleeve, as shown.



⚠ WARNING Hazardous pressure. Risk of severe injury or major property damage if tank explodes. Read the entire procedure before starting system or disassembling filter.

NOTE: Tightly close Drain Plug.

4. Open air relief plug located on top of vessel.

NOTE: Air trapped inside the filter greatly increases the explosion hazard.

5. Start pump.

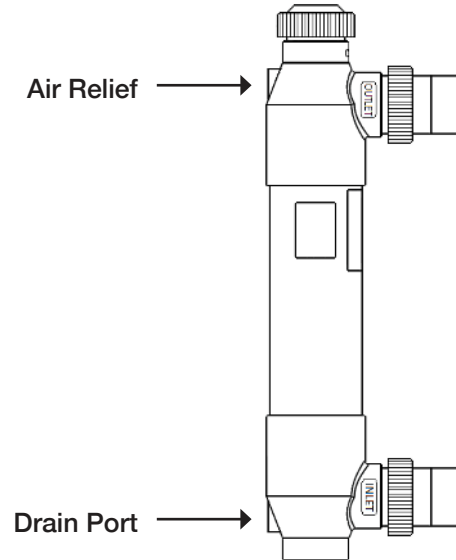

6. When a steady stream of water comes from air relief plug, close plug.
7. After thirty (30) minutes of recirculating water through the UV vessel, remove the paper towels from the quartz sleeve module. Inspect closely for moisture. If the paper towels are completely dry, the leak test is successful.
8. If moisture is detected on the paper towel the quartz sleeve's rubber gasket have failed to achieve a seal and must be re-assembled; repeat the leak test until a seal is achieved. See page 9 for assembly instructions.

INSTALLATION

Electrical Connection

The Bioshield UV system is intended to be permanently connected to a Listed Pool Controller (i.e. IntelliTouch® or EasyTouch® Control Systems) or a Listed Mechanical Timer Switch that provides a wiring compartment for the connection of ancillary equipment.

Connect the UV System ballast to a UL Listed Pool Controller:

1. Route the UV power supply cable through the 1/2-inch trade size conduit opening in the bottom of the control system enclosure.
2. Use the strain relief provided with the UV system to secure the power supply cable to the control system enclosure.
3. Connect the power supply cable leads to the appropriate terminations inside the control system.

NOTE: The cable leads are tinned, or provided with Listed Wiring Connectors (i.e. spade or closed loop), to allow for quick connection to a relay terminal, wiring bar or other conductor termination.

Connect the UV System ballast to a UL Listed Mechanical Timer Switch:

The UV system must be wired to the load side of the listed timer switch. This will ensure the UV system only operates when the pump is running. Refer to the instructions and wiring diagram below to properly wire the power supply to a listed timer switch.

1. Wire the power supply's BLACK lead to the terminal marked "L1".
2. Wire the power supply's WHITE lead to the terminal marked "N" (Neutral) in 120 VAC installations or to the terminal marked "L2" in 240 VAC installations.
3. Wire the GREEN lead to the terminal marked "GND" (Ground).

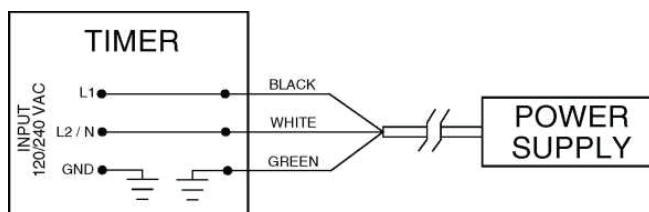

Connect the UV System ballast to the Flow Switch:

1. The UV lamp will not operate if there is a low flow condition.
2. Locate the cable with the black M12 female connector from the ballast.
3. Connect ballast cable connector to flow switch connector, by lining up the notch and twisting one of the connectors clockwise until snug allowing the two connectors to meet.



Flow Switch Electrical

The Bioshield UV system is intended to operate with an inline flow switch. The items provided are (1) flow switch with a M12 connector on a 10 foot cable, (1) 2.5"x1" (SxT) Tee and (2) 2.5"x2" (SxS) Reducers.

Flow Switch or Ballast Cable Adjustment

If the either of the device cables require shortening, the connectors can be removed and reinstalled. See Below

1. Loosen Cord grip nut (1).
2. Loosen Connector housing nut (3) (pull back housing as nut is loosened).
3. Pull back housing (2) to expose wire connections.
4. Loosen Screws (4) to release cable wires.
5. Cut cable to desired length and pair back cable jacket 1/2".
6. Pair back wire jacket 1/4".
7. Connect wires to pins 1 and 2.
8. Reassemble connector.



INSTALLATION

UV Lamp Installation

⚠ WARNING Failure to disconnect the power from the UV Sterilizer and pump before servicing the unit or replacing the lamp could result in personal injury or property damage. Confirm the lamp is completely off, via the view port, before attempting lamp replacement.

UV lamps are manufactured with color coded ceramic bases. Red-capped UV lamps signify a High-Output UV lamp.

Use only red-capped High-Output UV lamps with the Bioshield® UV.

NOTE: Care should be taken when installing the UV lamp into the vessel's quartz sleeve. Vertical installations require extra attention to eliminate the chance of the lamp dropping into the quartz sleeve and breaking.

1. Remove packaging from new UV lamp.
2. Slowly insert UV lamp into the middle of Clear Quartz Sleeve Module (7) until the 4-pins are just above the Clear Quartz Sleeve Module (7).
3. Connect the white 4-pin connector (2) to the UV lamp (1) by using a side to side motion until white 4-pin is touching the UV lamp red base.
4. Hold onto the cable (3) and slowly lower the UV lamp with white 4-pin connected into Clear Quartz Sleeve Module (7).
5. Once the Gray Power Supply Adapter (5) is touching the Clear Quartz Sleeve Module (7), tighten Gray Power Supply Adapter (5) into Clear Quartz Sleeve Module (7).
6. Hold onto the cable (3) and tighten the Watertight Cord Connector (4) until cable is secured.

7. Tighten Black View Port Cover (6) until it makes contact with the Clear Quartz Sleeve Module (7).

NOTE: If retrofitting the Black View Port Cover (P/N 960536) replaces Black Nut.

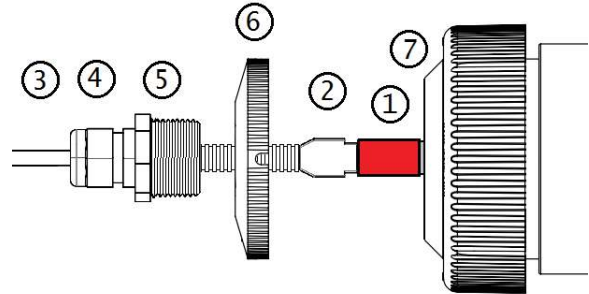

Power Cord Adjustment

The lamp spacer (3) is provided to ensure the proper distance (4" Space between 4-Pin (4) and Gray Power Supply Adapter (2)) is maintained for the UV lamp. The proper positioning is important for UV effectiveness.

1. The 3/8-inch Threaded Watertight Cord Connector (1) is adjustable. Loosen it gently move the cord through it. Care must be taken when retightening. If the Connector's Rubber Gasket Seal is dislodged during cord adjustment please make sure that it is properly re-seated inside the male threaded portion of the connector.

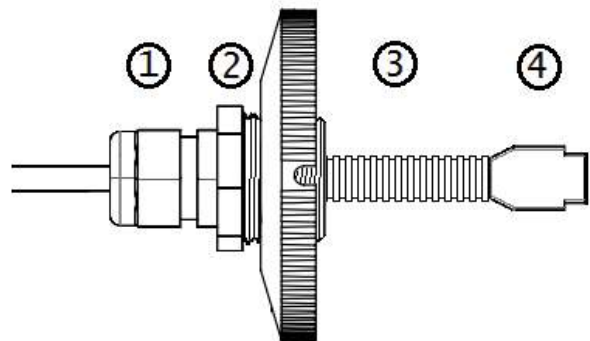

WARNING

A minimum 4-inch distance **must be** maintained between the Gray Reducer (2) and the White 4-pin Lamp Connector (4).

DO NOT REMOVE THE LAMP SPACER, ITEM #3!

INSTALLATION

2. After a successful leak test and without the power supply connected to a control box, attach the lamp's 4-pins to the power cord's white 4-pin Connector. Then slide the UV lamp back into the quartz sleeve.
3. Care should be taken when installing the UV lamp into the vessel's quartz sleeve. Vertical installations require extra attention to eliminate the chance of the lamp dropping into the quartz sleeve and breaking.
4. With the UV lamp/power cord connection complete and the lamp entirely inside the quartz sleeve, carefully tighten down the Gray Power Supply Adapter (5) onto the Clear Quartz Sleeve Module (7) hand tighten only.

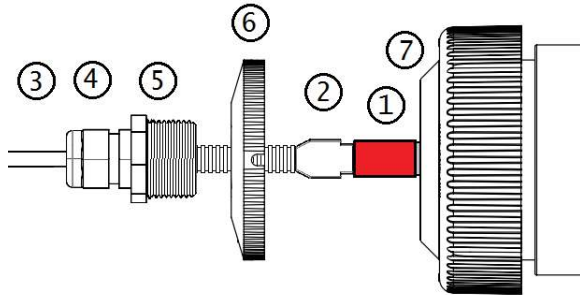

5. Tighten down the Black View Port Cover (6) (P/N 960536) until it makes contact with the Clear Quartz Sleeve Module (7).

NOTE: If you do not have the Black View Port Cover (6) back far enough before tightening the Gray Power Supply Adapter (5), the gray adapter will not make contact with the power supply gasket and will enable outside moisture to enter the quartz sleeve assembly and cause a system failure.

OPERATION

Initial Start-Up

1. Verify the black nut for the quartz sleeve module is secure.
2. If in vertical position loosen air bleed valve to allow air to escape the unit and drain plug is secured.
3. Turn on pump.
4. Close the air bleed valve once a steady stream of water emerges.
5. Energize UV system ballast.
 - a. The ballast will delay the UV Lamp from illuminating for 25 seconds.
 - b. The 25 second delay is activated by either a manual power on or a flow switch trigger.
6. Check the UV Lamp for illumination via the view port at either end of the unit.
7. Once the UV Lamp is illuminated and there are no leaks the startup is complete.
8. The flow switch will control the UV lamp during flow and low flow conditions.

System Flow Rate Trigger Points	
2.5" Schedule 40 Tee	
Off Trigger	On Trigger
11 GPM	19 GPM

⚠ DANGER



This filter operates under pressure. With the valve clamped properly and operated without air in the system, this filter will operate in a safe manner. Air entering the filter and the valve not clamped correctly can cause the valve to separate, which could cause serious personal injury and/or property damage.

⚠ WARNING

Always turn pump off before changing valve positions. Changing valve positions while the pump is running can damage the control valve, which may cause serious injury or property damage.

MAINTENANCE

UV Lamp Replacement (Latex or Cotton Gloves)

⚠️ WARNING Failure to disconnect the power from the UV Sterilizer and pump before servicing the unit or replacing the lamp could result in personal injury or property damage. Confirm the lamp is completely off, via the view port, before attempting lamp replacement.

Removing UV Lamp

1. Loosen Black Jamb Nut (6) until it no longer makes contact with the Clear Quartz Sleeve Module (7).
2. Hold onto the cable (3) and loosen the Watertight Cord Connector (4) by no less than 2 full revolutions.
3. Hold onto the cable (3) and loosen Gray Power Supply Adapter (5) until disengaged from the Clear Quartz Sleeve Module (7).
4. Slowly pull the UV Lamp assembly straight out of the quartz sleeve until the white 4-pin connector (2) and UV lamp (1) are visible.
5. Using Latex or cotton gloves hold onto lamp and use side to side motion to disconnect the white 4-pin connector (2) from the UV lamp (1).
6. Once disconnected, pull the UV lamp straight out of the quartz sleeve, until UV lamp is free from the Clear Quartz Sleeve Module (7).
7. Set removed UV lamp to the side, in a safe area.

UV Lamp Installation

UV lamps are manufactured with color coded ceramic bases. Red-capped UV lamps signify a High-Output UV lamp.

Use only red-capped High-Output UV lamps with the Bioshield® UV.

NOTE: Care should be taken when installing the UV lamp into the vessel's quartz sleeve. Vertical installations require extra attention to eliminate the chance of the lamp dropping into the quartz sleeve and breaking.

1. Remove packaging from new UV lamp.
2. Slowly insert UV lamp into the middle of Clear Quartz Sleeve Module (7) until the 4-pins are just above the Clear Quartz Sleeve Module (7).
3. Connect the white 4-pin connector (2) to the UV lamp (1) by using a side to side motion until white 4-pin is touching the UV lamp red base.
4. Hold onto the cable (3) and slowly lower the UV lamp with white 4-pin connected into Clear Quartz Sleeve Module (7).
5. Once the Gray Power Supply Adapter (5) is touching the Clear Quartz Sleeve Module (7), tighten Gray Power Supply Adapter (5) into Clear Quartz Sleeve Module (7).
6. Hold onto the cable (3) and tighten the Watertight Cord Connector (4) until cable is secured.
7. Tighten Black View Port Cover (6) until it makes contact with the Clear Quartz Sleeve Module (7).

NOTE: If retrofitting the Black View Port Cover (P/N 960536) replaces Black Nut.

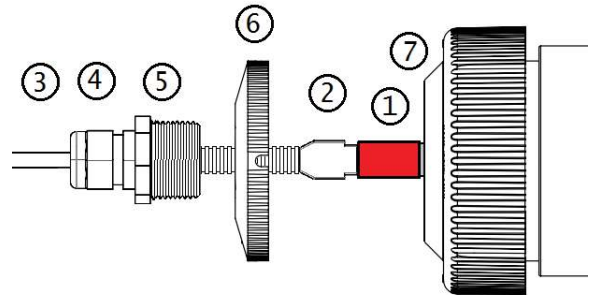

Quartz Sleeve Cleaning

It is recommended that the quartz sleeve be visually inspected for cleaning once every six months of operation. Even the slightest layer of material (slim/dirt) coating the outside of the quartz sleeve can have a substantial effect on UV-C light transmittance through the glass and into the water.

MAINTENANCE

To Clean the Quartz Sleeve (for above water-level installations only):

1. Disconnect power to the UV and pool pump at the circuit breaker.
2. Relieve any residual pressure that may remain in the system.
3. Unthread the Black Retaining Nut and gently remove the Quartz Sleeve Assembly and lamp from the UV vessel.
4. Inspect the Quartz Sleeve and clean as needed with a soft, clean cloth.
5. If calcium deposits are present use vinegar or a mixture of water and muriatic acid to dissolve the deposits. If using muriatic acid a ratio of four parts water to one part acid should suffice. Always introduce acid to the water and never introduce the water to the acid.

⚠ WARNING Muriatic acid is corrosive and can lead to inflammation or burns to body tissue. ALWAYS wear rubber gloves, safety glasses and an N-95 dust mask when handling acid to prevent serious bodily injury.

6. Remove ALL vinegar or acid from the quartz sleeve assembly before reassembling.
7. Refer to “Initial Start-Up” to put UV System back in service.

Winterizing

Using the Bioshield® UV in extremely cold temperatures can cause damage to the unit, especially if the water is allowed to freeze inside the equipment. Please note that damage to the product due to freezing is not covered under warranty.

Pentair recommends shutting the UV system down when the temperature consistently falls below 40°F (4°C).

1. Drain all water from the UV system.
2. Disassemble the entire unit and carefully clean both the outside and interior of the UV body and components.
3. Once clean and dry, store the UV vessel and power supply in a dry place for the winter.
4. Return the UV system to service when temperatures consistently return to 40°F (4°C) or greater.

NOTE: Be sure to replace the quartz sleeve gasket and perform a leak test prior to operating the equipment.

TROUBLESHOOTING

Mandatory Leak Test Indicates a Leak

1. Turn off the pool pump at the circuit breaker and be sure all flow to the unit has been stopped.
2. Refer to page 9 for “Quartz Sleeve Assembly” and page 14 for “UV Lamp Installation” (in reverse order) to disassemble the unit.
3. Ensure there are no cracks or breakages in the Quartz Sleeve, that the Quartz Sleeve Gasket and O-ring are properly installed, and that the Quartz Sleeve Retaining Nut has been tightened down completely
4. Reassemble the Quartz Sleeve (see page 9) and repeat the Mandatory Leak Test (see page 12) until there are no indications of a leak.

GFCI/Breaker is tripping

1. Immediately disconnect power to the Bioshield® UV.
2. Turn off the pool pump at the circuit breaker and be sure all flow to the unit has been stopped.
3. Refer to page 9 for “Quartz Sleeve Assembly” and page 14 for “UV Lamp Installation” (in reverse order) to disassemble the unit.
4. Check for water/moisture inside the quartz sleeve.
5. Multiple appliances connected to a circuit protected by one GFCI create the potential for cumulative leakage current resulting in a tripped GFCI.

REPLACEMENT PARTS

Revision 3 UV unit with Flow Switch

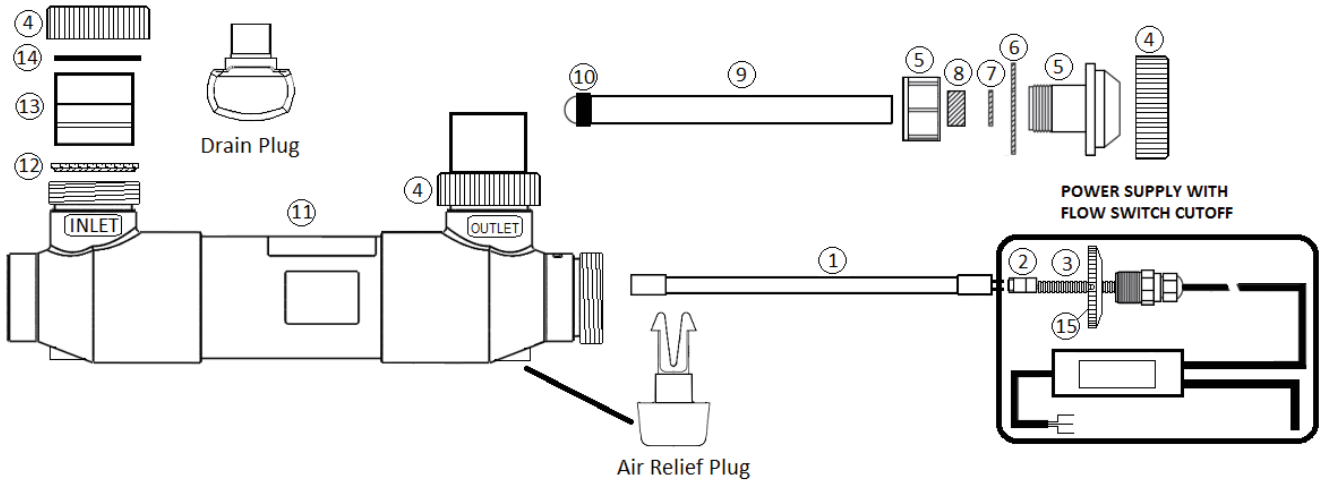

Item #	Description	P/N
1	UV Lamp	Below
2	4-Pin Lamp Connector	523034
3	UV Lamp Spacer	523423
4	Black Retaining Nut	411000
5, 7, 8	Quartz Sleeve Retaining Module	523382
6, 7, 8	Seal Kit	523383
9	Quartz Sleeve	Below

Item #	Description	P/N
10	Quartz Sleeve Dampener Band	523403
11	UV Vessel (Only)	Below
12	Union Sealing Gaskets (Qty 2)	410016Z
13	Union Adapter (Qty 1)	410002
14	Union Clip Ring (Qty 1)	410001
15	View Port Cover Kit	960536
Not Shown	Vessel 3" Clamps Kit (Qty 2)	523098

BOLDED PARTS REQUIRE ANNUAL REPLACEMENT

Model No.	UV Lamp P/N	Quartz Sleeve P/N	Power Supply P/N	UV Vessel P/N	Air Relief Plug P/N	Drain Plug P/N	Flow Switch P/N
522635	523035	523039	523460	523110	25010-0004	357161	523458
522636	523036	523040	523460	523111			
522637	523037	523041	523460	523112			
522638	523038	523042	523462	523113			

REPLACEMENT PARTS

Revision 3 UV unit

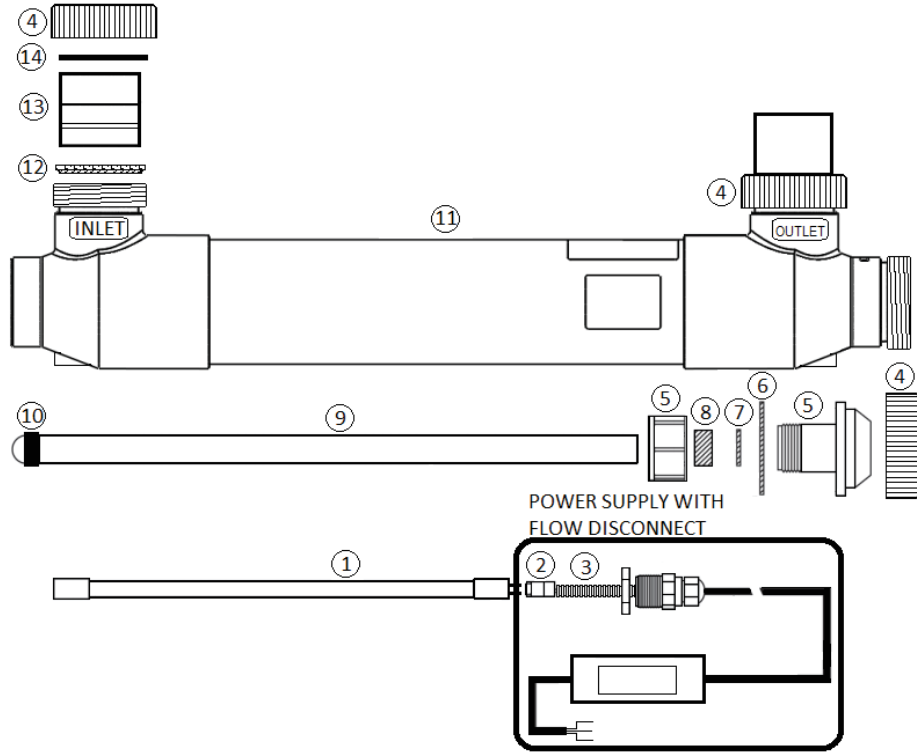

Item #	Description	P/N
1	UV Lamp	Below
2	4-Pin Lamp Connector	523034
3	UV Lamp Spacer	523423
4	Black Retaining Nut	411000
5, 7, 8	Quartz Sleeve Retaining Module	523382
6, 7, 8	Seal Kit	523383
9	Quartz Sleeve	Below

Item #	Description	P/N
10	Quartz Sleeve Dampener Band	523403
11	UV Vessel (Only)	Below
12	Union Sealing Gaskets (Qty 2)	410016Z
13	Union Adapter (Qty 1)	410002
14	Union Clip Ring (Qty 1)	410001
Not Shown	3" Union Kit (Qty 2) (100 GPM)	523148
Not Shown	Vessel 3" Clamps Kit (Qty 2)	523098

BOLDED PARTS REQUIRE ANNUAL REPLACEMENT

Model No.	UV Lamp P/N	Quartz Sleeve P/N	Power Supply P/N	UV Vessel P/N	Air Relief Plug P/N	Drain Plug P/N	Flow Switch P/N
522635	523035	523039	523032	523110	25010-0004	357161	523458
522636	523036	523040	523032	523111			
522637	523037	523041	523032	523112			
522638	523038	523042	523033	523113			
522945	523038	523042	523053	523113			

REPLACEMENT PARTS

Revision 2 UV unit

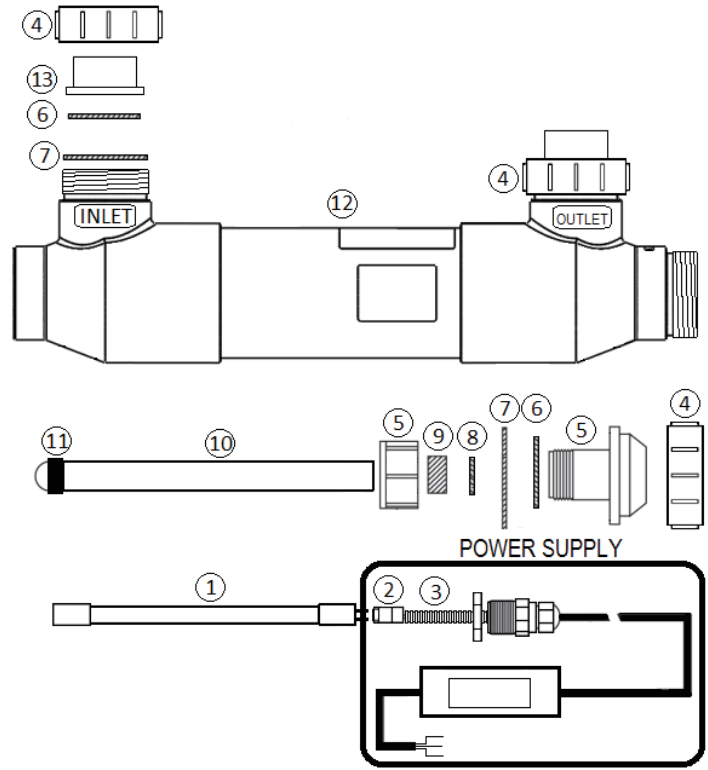

Item #	Description	P/N
1	UV Lamp	Below
2	4-Pin Lamp Connector	523034
3	UV Lamp Spacer	523423
4	Retaining Nut	523121
5, 6, 8, 9	Quartz Sleeve Retaining Module	523375
6, 7, 8, 9	Seal Kit	523031

Item #	Description	P/N
10	Quartz Sleeve	Below
11	Quartz Sleeve Dampener Band	523403
12	UV Vessel (Only)	Below
7, 6, 13, 4	Union Kit (Qty 2)	523375
Not Shown	3" Union Kit (Qty 2) (100 GPM)	523148
Not Shown	Vessel 3" Clamps Kit (Qty 2)	523098

BOLDED PARTS REQUIRE ANNUAL REPLACEMENT

Model No.	UV Lamp P/N	Quartz Sleeve P/N	Power Supply P/N	UV Vessel P/N	Air Relief Plug P/N	Drain Plug P/N	Flow Switch P/N
522635	523035	523039	523032	523110	25010-0004	357161	523458
522636	523036	523040	523032	523111			
522637	523037	523041	523032	523112			
522638	523038	523042	523033	523113			

***NOTE: Replacement UV Vessels will be REV3**



1620 HAWKINS AVE., SANFORD, NC 27330 • (919) 566-8000
10951 WEST LOS ANGELES AVE., MOORPARK, CA 93021 • (805) 553-5000
WWW.PENTAIR.COM
©2018 Pentair Water Pool and Spa, Inc. All rights reserved.
This document is subject to change without notice.



P/N 960080 Rev. 1 8/19